

METAL DJ DESK





METAL DJ DESK

- 3-piece powder-coated aluminium construction allows for interchangeable desktops, offering a choice of three widths for any configuration of equipment
- Lightweight (under 25 kg)
- Assembly time 10 minutes
- Ergonomic, detachable laptop-stand slides to your desired position (15" maximum screen-size)
- All leads, connections and PSUs concealed
- Customisable finish: any colour or choice of design can be applied
- Solid rubber feet
- Perfect for Live use, easily packaged in two cardboard boxes
- Designed and handmade in Berlin, Germany



SIZE S

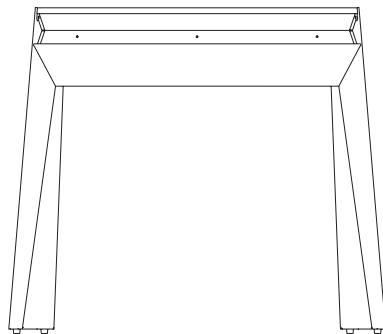
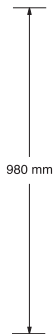
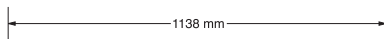
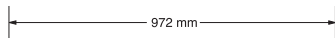
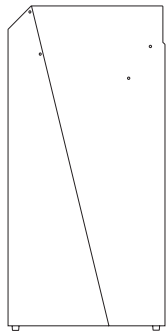
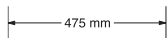



SIZE M

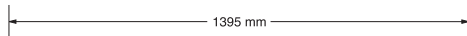
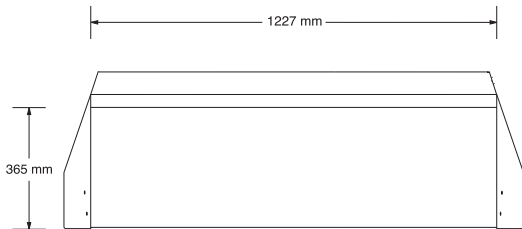
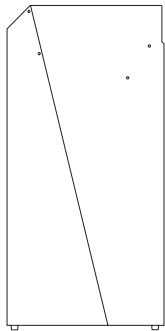
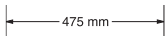



SIZE L

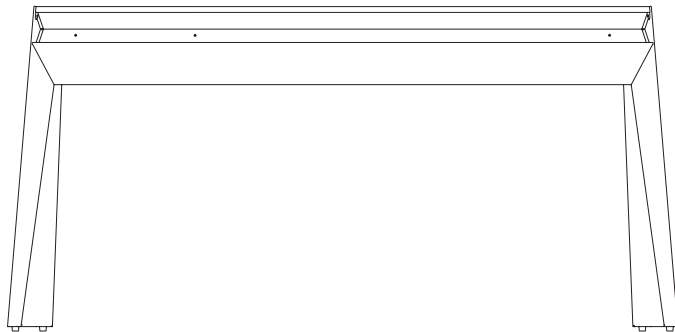
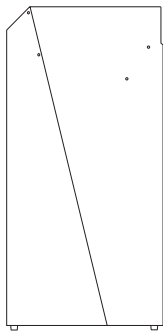
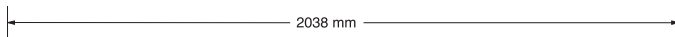
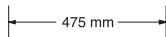



POSSIBLE EQUIPMENT COMBINATIONS

SIZE S

2 x Pioneer CDJ 1000
1 x Pioneer DJM 800

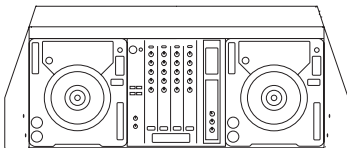

SIZE M

2 x Technics SL-1210
1 x Pioneer DJM 800

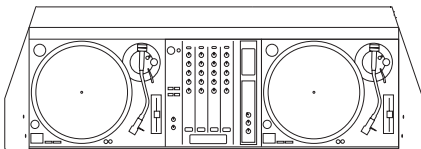

SIZE L

2 x Pioneer CDJ 1000
2 x Technics SL-1210
1 x Pioneer DJM 800

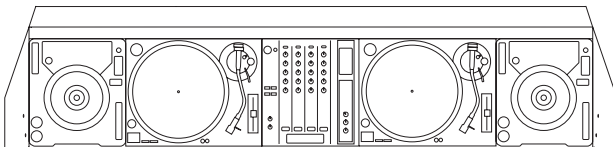



LAPTOP STAND

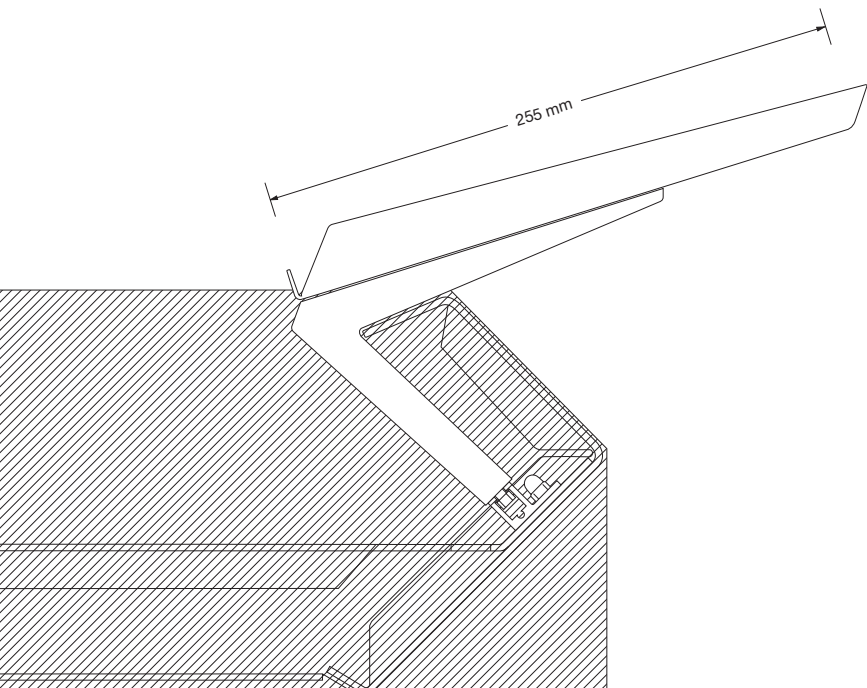



The easy-to-install laptop-stand can hold up to a 15" screen laptop. Depth 255 mm, Width 435 mm



The aluminium track allows you to slide your laptop-stand into the ideal position. Anti-slide rubber fittings keep your laptop in place.

WIRE CHANNEL

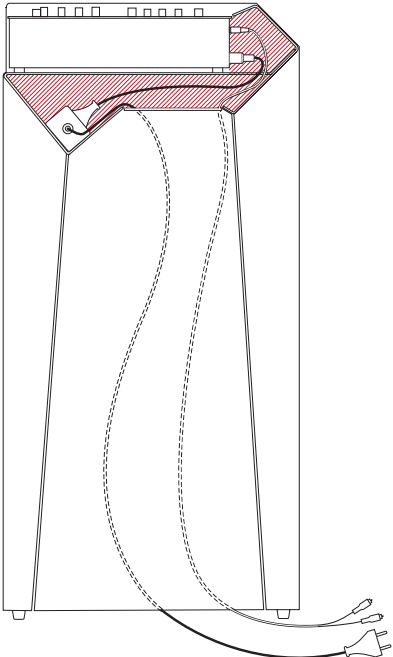



All leads, connections, plug-boards and Power-Supply Units can be concealed underneath desktop and behind detachable leg panels.

Three holes allow cables to be fed through to hollow legs.

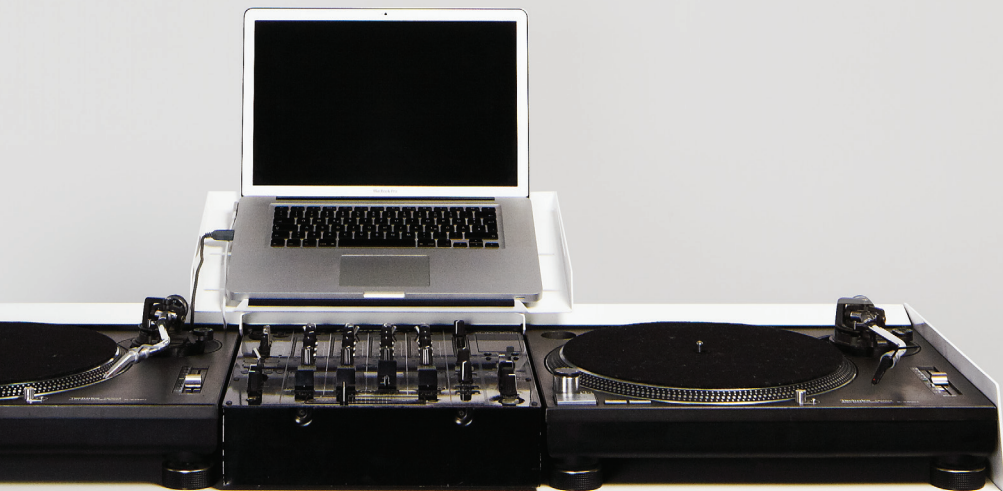



PRICING*

| | |
|-------------------------------------|---------|
| SIZE S | 999 € |
| SIZE M | 1.199 € |
| SIZE L | 1.299 € |
| LAPTOP STAND (with aluminium track) | 349 € |

Standard delivery time 3 weeks,
ask for individual shipping fee.

* Technical equipment not included



info@**DJ-DESK**.com

Metrofarm GmbH
Lobeckstrasse 36
D-10969 Berlin

+49 30 2345 77 53
www.metrofarm.net



graphic design: Susanne Westphal photography: Noshe

www.DJ-DESK.com

